

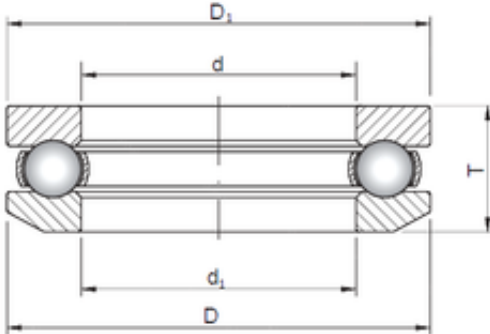

ISO 53244 thrust ball bearings



Bearing No. 53244

Bore Diameter	220 mm
Outer Diameter	295 mm
d	220 mm
d1	224 mm
D	295 mm
D1	300 mm
T	65,6 mm

53244 Bearing 2D drawings and 3D CAD models